

DOWNLIGHT REINVENTED

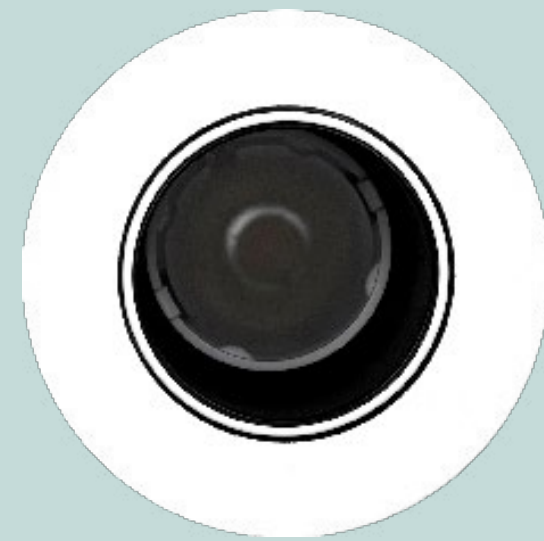

50 Range 1982



40 Range 2018



30 RANGE 2019



OUR *smallest* EVER

OUR *smallest* EVER DOWNLIGHT RANGE

When John Cullen introduced the first halogen downlight in 1982, they were the smallest on the market. Now with our range of 30 downlights, we are able to once again reinvent this genre with even smaller discreet fittings. The new design has all the functionality and adaptability you have come to expect from the 50 and 40 range but in a new miniature downlight with “best in class” light quality and high lumen output.



NUMBERS DO
THE TALKING

1

Minature powerful light engine offering ≥ 300 lumens.



2

Stock colours to suit your scheme.

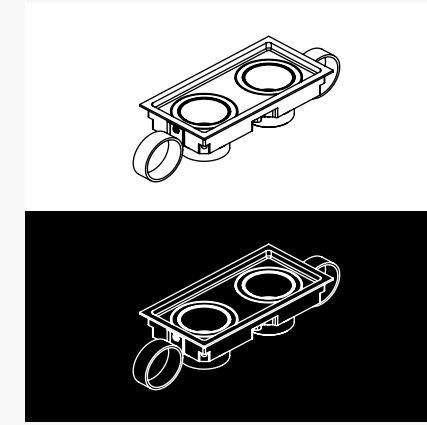

3

Beam angles to light more precisely.

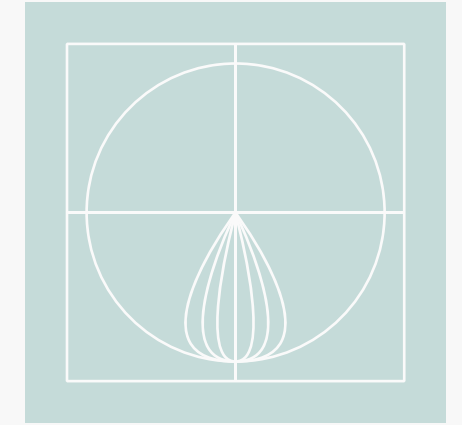

10

Different luminaire styles to choose the effect you require.

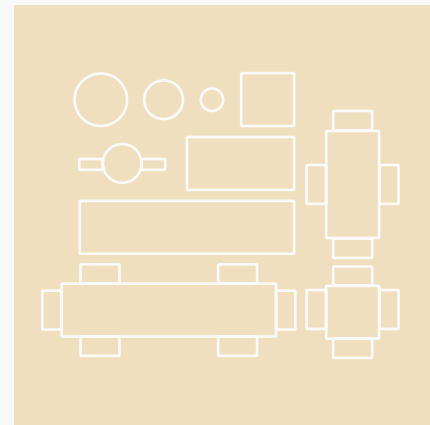

300

Tilt to direct the beam.

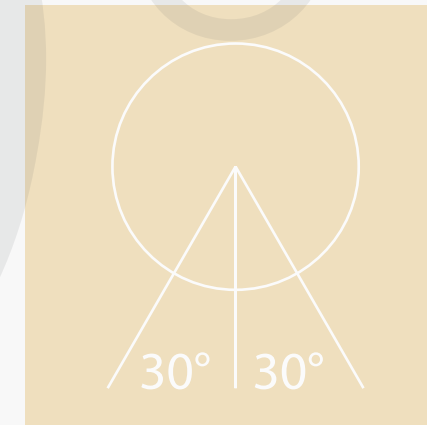

32

Cut out smallest.

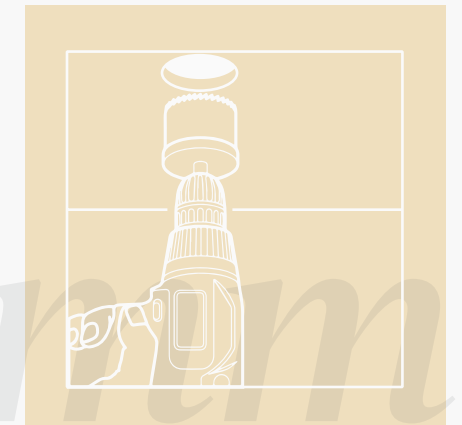

55

Minimum recess depth required.



600

Combinations for you to create your ideal effects.



1000%

Created with our brand DNA at heart.

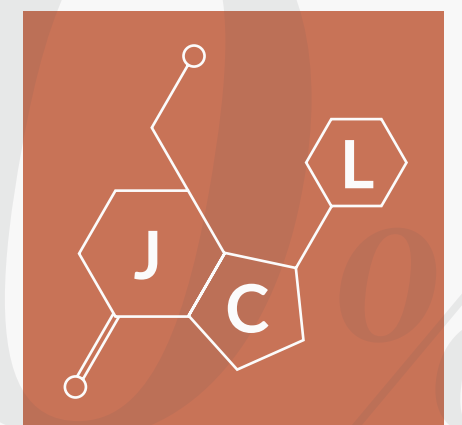

SPECIFICATION BREAKDOWN

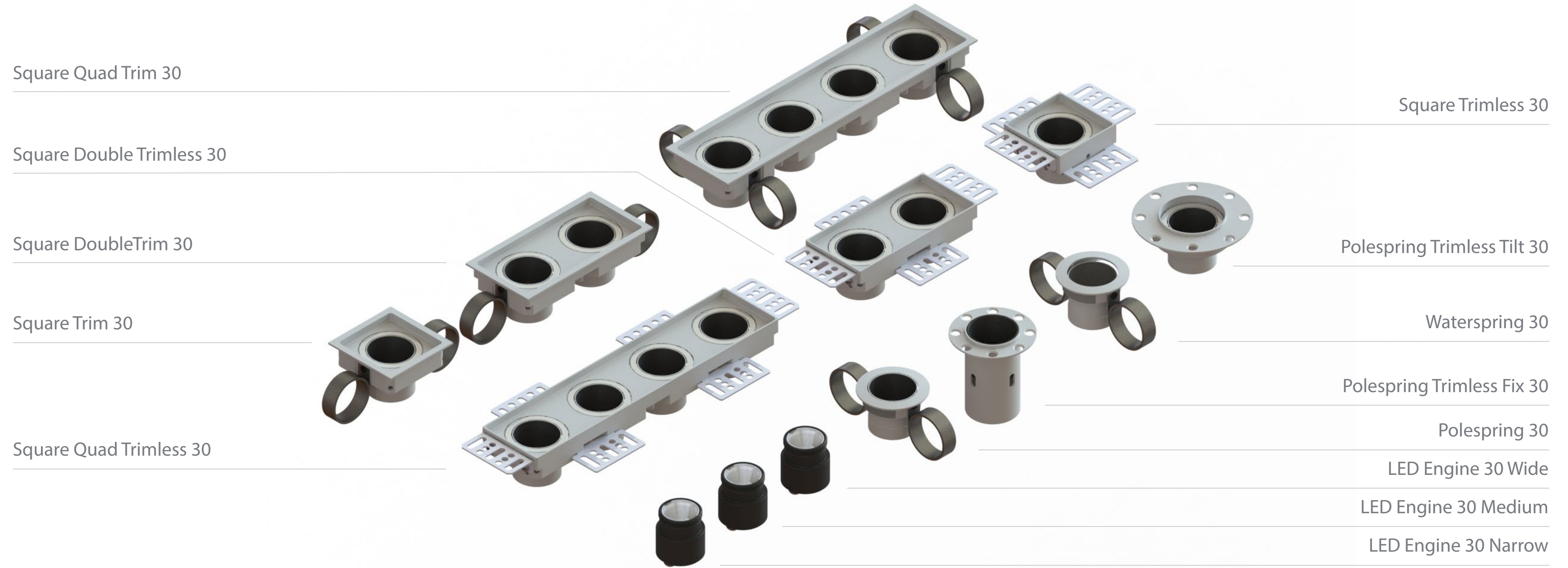

To explore the full range, please click [here](#).

	LED ENGINE	LED ENGINE	LED ENGINE
Beam Angle	10°	26°	46°
LED Source Lumens typ.	380 lm	380 lm	380 lm
Engine Lumens typ.	360 lm	350 lm	350 lm
Luminaire Lemns typ.	315 lm	310 lm	305 lm
Intensity Rating typ.	4500	1700	550
Power Consumption	4W	4W	4W
Luminaire Efficacy	78 lm/W	77.5 lm/W	76 lm/W
Colour Temperature	2700K (stock)	2700K (stock)	2700K (stock)
CRI typ.	93	93	93
Colour Fidelity typ. (Rf)	91	91	91
Colour Gamut typ. (Rg)	100	100	100
Binning	2 Step	2 Step	2 Step
Lifetime L70/B10 (hours)	>50,000	>50,000	>50,000
Forward Voltage	11.3V	11.3V	11.3V
Current Rating	350mA	350mA	350mA
Product Class	Class III	Class III	Class III

JOHN
CULLEN

INSPIRE WITH LIGHT

GET IN TOUCH

LONDON SHOW
ROOM & STUDIO

561-563 King's Rd,
London SW6 2EB

E — sales
@ [johncullenlighting.com](mailto:sales@johncullenlighting.com)

DUBAI STUDIO

2905, JBC2, Cluster V,
Jumeirah Lakes Towers,
PO Box 643550 Dubai

E — sales
@ [johncullenlighting.ae](mailto:sales@johncullenlighting.ae)

PARIS STUDIO

10, Rue du Colisée
75008 Paris
France

E — studio
@ [johncullenlighting.fr](mailto:studio@johncullenlighting.fr)



@johncullenlighting